

# ***OKEYH POOL Products***

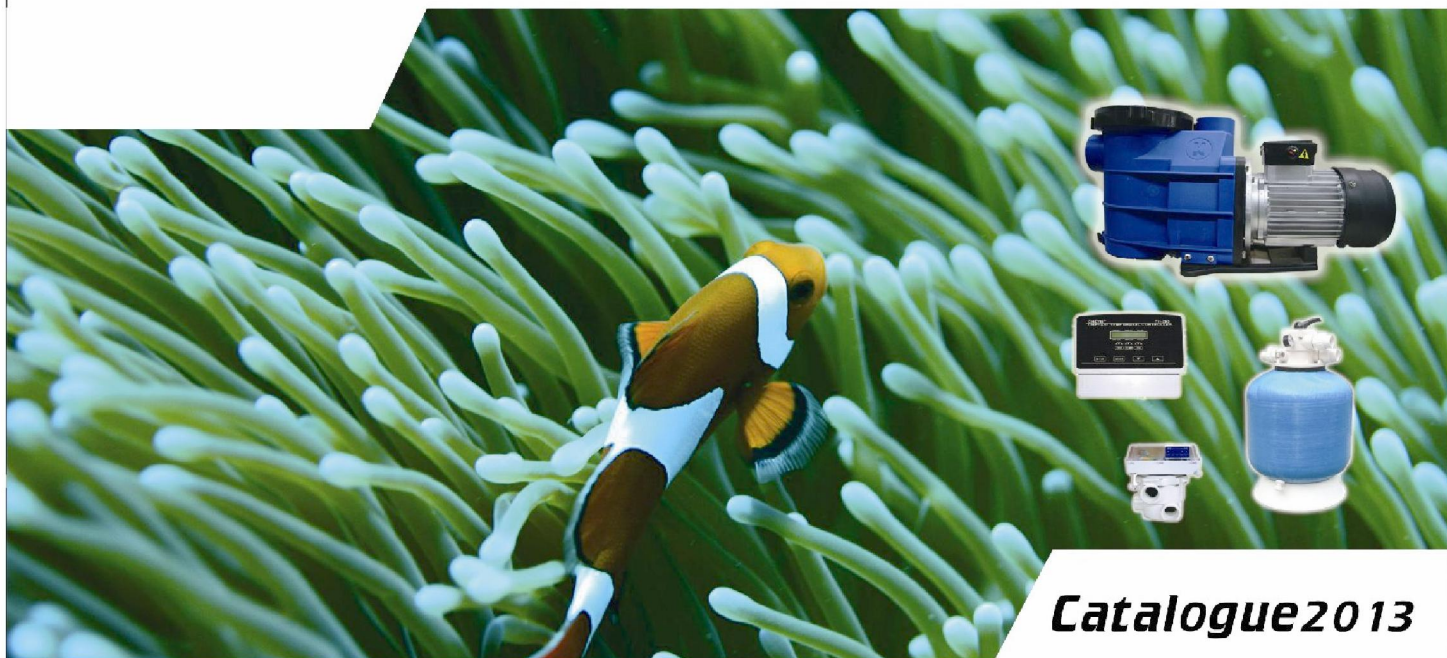

***Catalogue2013***



The final interpretation right of this event is reserved by TAT HING company

# OKEYH POOL PRODUCTS



# Okeyh ,Your Pool Master

<b>Advertising</b> .....	<b>Q1</b>
<b>Content</b> .....	<b>Q2</b>
<b>Horizontal Bobbin Wound Sand Filter</b> .....	<b>1</b>
<b>FA Series - Deep Bed Type 1</b> .....	<b>2</b>
<b>FA Series - Deep Bed Type 2</b> .....	<b>3</b>
<b>FB Series - Side Mount Type</b> .....	<b>4</b>
<b>FB Series - Top Mount Type</b> .....	<b>5</b>
<b>FC Series - Top Mount Clamp Type</b> .....	<b>6</b>
<b>Six Way Multiport Valve</b> .....	<b>7</b>
<b>Cartridge Filter</b> .....	<b>8</b>
<b>All-in-one Filter System</b> .....	<b>9</b>
<b>FI Series - Mild Steel Vessel Type</b> .....	<b>10</b>
<b>Hub and Nozzle</b> .....	<b>11</b>
<b>KL and KLP Series</b> .....	<b>12</b>
<b>KT Series</b> .....	<b>13</b>
<b>KH Series</b> .....	<b>14</b>
<b>KRF Series</b> .....	<b>15</b>
<b>Salt Chlorinator</b> .....	<b>16,17</b>
<b>Electrical Six-Way Multiport Valve</b> .....	<b>18</b>
<b>ORP/PH/Temp Digital Controller</b> .....	<b>19</b>
<b>Wall Mount Pool Skimmer</b> .....	<b>20</b>
<b>Pool Fittings Accessories and Drains</b> .....	<b>21</b>
<b>Pool Fittings - Jet Air Nozzle</b> .....	<b>22</b>
<b>PVC Pipe Fitting</b> .....	<b>23</b>
<b>Pool Plastic Grating</b> .....	<b>24</b>
<b>Pool Accessories</b> .....	<b>25,26</b>
<b>Pool Racing Lane and Float Ball</b> .....	<b>27</b>
<b>Starting Block and Pool Ladder</b> .....	<b>28</b>
<b>Stainless Steel Life Guard Chair and Take Up Reel</b> .....	<b>29</b>
<b>Wall Mount Pool Light</b> .....	<b>30</b>
<b>LED Pool Light and Fountain Light Series</b> .....	<b>31</b>
<b>Jumping Jet Fountain HT-950</b> .....	<b>32</b>
<b>Fountain Nozzle</b> .....	<b>33-36</b>
<b>Brass Curtain Fountain Nozzle</b> .....	<b>37</b>
<b>Electric Heater for Spa</b> .....	<b>38</b>
<b>Steam Generator</b> .....	<b>39</b>
<b>Sauna Accessories</b> .....	<b>40</b>

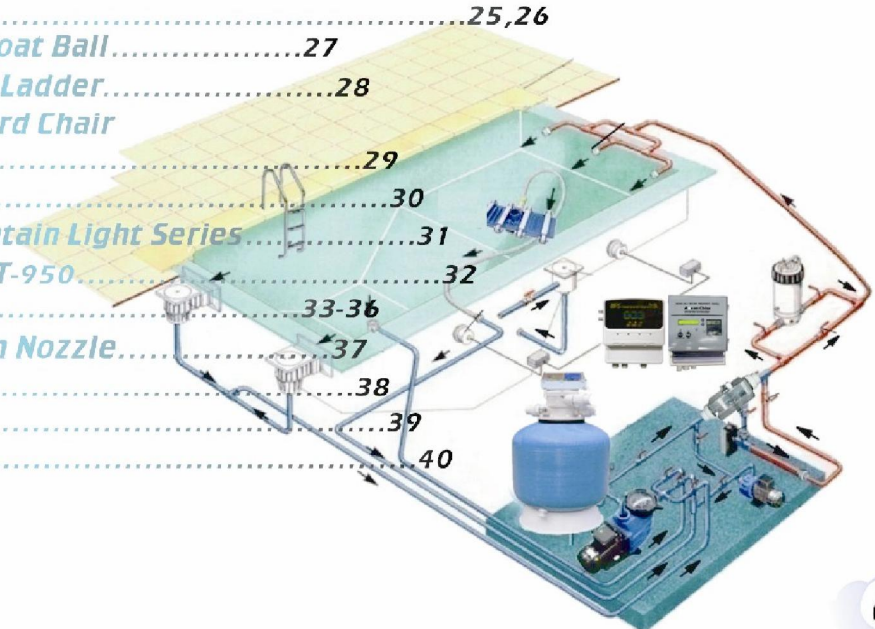



# Horizontal Bobbin Wound Sand Filter

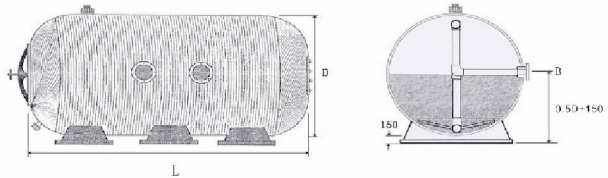

The horizontal sand filters made with polyester resin and winding glass fiber can be applied to the water filtration in public pools, aquatic parks, irrigation water and water treatment in general. They provide a great surface area for filtration with a limited space and a very economic costs. Manual or automatic valve battery are available with 3" to 8" depending on the filtration rate required. The standard models of horizontal filters can work under pressure 2.5 bar or 4 bar. Custom-made horizontal filters can be made if required and possible

- Features:**
- With bobbin wound body large man hole
  - inlet & outlet with flanges, sand and water drain included
  - Filtration bed depths 0.6m 1.0m or 1.2m
  - Working pressure 2.5 bar or 4 bar
  - Lateral collector, manometer panel & air bleed system
  - Lateral inspection hole optional

Filter Model	Dia. mm	Length mm	Area m <sup>2</sup>	Flange B	Flow Rate m <sup>3</sup> /h	Filter Rate m <sup>3</sup> /m <sup>2</sup> /h	Pressure bar	Sand Weight (KG)
FH-1001503B25	1000	1500	1.3	3"	26-52	20-40	2.5	1126
FH-1002004B25	1000	2000	1.8	4"	36-72	20-40	2.5	1502
FH-1402506B25	1400	2500	3.22	6"	64.4-128.8	20-40	2.5	3681
FH-2002506B25	2000	2500	4.6	6"	92-184	20-40	2.5	7500
FH-2003206B25	2000	3200	6	6"	120-240	20-40	2.5	9600
FH-1002003B40	1000	1500	1.3	3"	26-62.4	20-48	4	1126
FH-1002004B40	1000	2000	1.8	4"	36-86.4	20-48	4	1502
FH-1402506B40	1400	2500	3.22	6"	64.4-154.6	20-48	4	3681
FH-2002506B40	2000	2500	4.6	6"	92-220.8	20-48	4	7500
FH-2003206B40	2000	3200	6	6"	120-288	20-48	4	9600



# FA Series - Deep Bed Type 1



FA Series



Height  
2000mm

with side hole  
for easy installation  
or maintenance



**DFB filter are manufactured with lateral collector . Their high quality filtration ability thanks to the large and deep filtering bed both on filtering area and depth.**

**They include drain, pressure gauge , multiport valve and connecting parts to filter.**

**Connecting: 2" / 60mm / 63mm**

**Max. working pressure: 2.5 bar or 2.5 kg/cm<sup>2</sup>**

**Max. temperature: 40° C**

Model	Dia.mm	Flow Rate m <sup>3</sup> /h	Mp Valve Side-mount	Height mm
DFB-003	750	13	HT-920	2000
DFB-004	900	19	HT-920	2000



# FA Series - Deep Bed Type2



**FA SERIES**

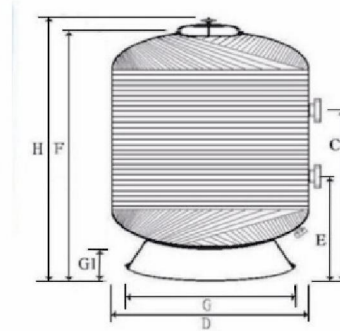

## FA series deep bed filters features including:

- **Manufactured with wounded fiberglass polyester**
- **Having a large man hole and 1.2m depth filtration bed**
- **Lateral underdrains or nozzle panel**
- **Complete with air bleed system, sand and water drain, plus pressure gauge panel**
- **Inlet and outlet are flanged or thread connections according to filter sizes**
- **Working pressure: 2.5 bar. Special are made to order**



REF. Model	Diametermm	Connctetion mm	Flow m <sup>3</sup> /H	Surface Area m <sup>2</sup>	Efficiency%	Sand Weight KG	Pressure KG/CM <sup>2</sup>	H MM	C MM	E MM	F MM	G MM	G1 MM
FA-005	1050	80/3"	43	0.86	95	1050	2.5	2070	1390	590	1940	950	240
FA-006	1200	100/4"	56	1.13	95	1500	2.5	2000	1405	605	1950	1000	245
FA-025	1400	125/5"	77	1.54	95	2000	2.5	2175	1490	690	2045	1100	265
FA-007	1600	150/6"	100	2.01	95	2650	2.5	2310	1560	760	2180	1510	310
FA-026	1800	150/6"	125	2.54	95	2350	2.5	2320	1600	800	2190	1580	300
FA-008	2000	150/6"	157	3.14	95	4100	2.5	2420	1640	840	2290	1780	290
FA-009	2300	200/8"	217	4.34	95	5700	2.5	2520	1785	985	2390	1940	335

# FB Series - Side Mount Type



## RESIDENTIAL

We present you an extensive programme of filters manufactured with polyester and glassfiber winding for high resistance and high quality of water filtration. FB series filters are indicated for private, fish pool, Jacuzzi and public pools, and equipped with:

- Multi-port 6-way valve (bolts mounted) with lever-action handle
- Integral sight glass for watching backwash cycle
- Manometer, air-bleed apparatus for monitoring and varying the pressure of filtration system
- Large pressure sand/water drain for rapid winterizing or servicing
- Umbrella-fold self cleaning laterals for balanced flow, backwashing and easy maintenance
- Maximum working pressure: 2.5 bars

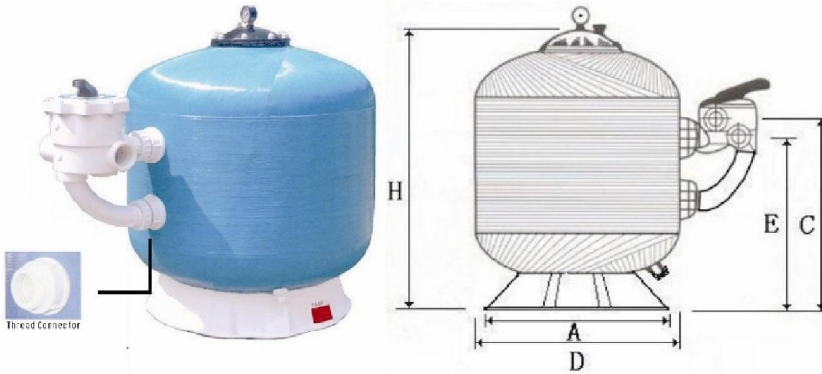

REF. Model	Diameter mm	Connctction mm	Flow m <sup>3</sup> /H	Surface Area M <sup>2</sup>	Efficiency%	Sand Weight KG	Pressure KG/CM <sup>2</sup>	H MM	Ø MM	C MM	E MM
FB-001	500	48/50	6-9	0.196	95	120	2.5	811	460	551	470
FB-002	600	48/50	9-14	0.283	95	200	2.5	891	460	594	513
FB-003	750	60/63	13-21	0.442	95	300	2.5	1006	590	643	562
FB-004	900	60/63	19-30	0.636	95	400	2.5	1228	790	779	698
FB-005	1000	75/76	24-37	0.785	95	550	2.5	1233	945	787	707
FB-006	1200	75/76	33-54	1.131	95	750	2.5	1433	1010	981	820

## COMMERCIAL

FB series filters with flange connection include with:

- Superior manhole
- Filtration bed with 1 meter of sand
- Stainless steel hubs and laterals
- Airbleed system
- Drain for sand and water
- Manometer panel
- Inlets and outlets with detachable unions or flanges
- Working pressure: 2.5 bar or 4 bar

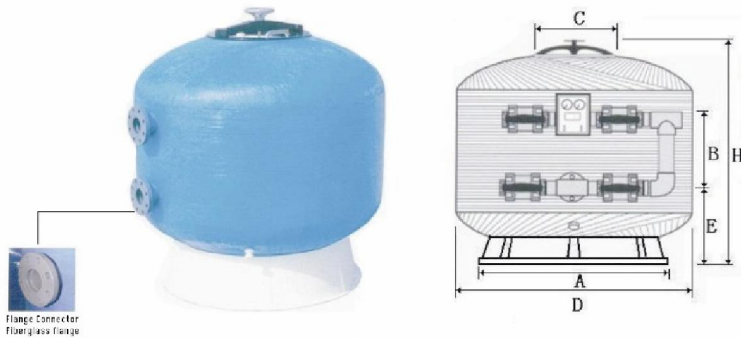

REF. Model	Diametermm	Connctction mm	Flow m <sup>3</sup> /H	Surface Area M <sup>2</sup>	Efficiency%	Sand Weight KG	Pressure KG/CM <sup>2</sup>	H MM	Ø MM	C MM	E MM	B MM
FB-064	1200	3"	33-54	1.01	95	750	2.5	1400	1010	500	550	340
FB-067	1400	3"	46-73	1.54	95	1600	2.5	1620	1150	500	665	340
FB-200	1600	4"	60-100	2.01	95	2300	2.5	1760	1440	500	685	440
FB-044	1200	3"	33-54	1.01	95	1400	2.5	1000	1020	500	725	440
FB-047	1400	4"	46-73	1.54	95	1900	2.5	1000	1230	500	735	440
FB-173	1600	4"	60-100	2.01	95	2600	2.5	1900	1440	500	780	440
FB-174	1800	6"	76-122	2.55	95	3500	2.5	1940	1570	500	810	440
FB-186	2000	6"	94-150	3.14	95	4500	2.5	2000	1730	500	825	440
FB-190	2300	8"	130-200	4.34	95	6000	2.5	2360	1760	500	1020	600
FB-199	2500	8"	150-235	4.91	95	8300	2.5	2450	1760	500	900	600



# FB Series - Top Mount Type

## TOP MOUNT (BOLTS ON)

FB series high performance sand filter (Top Mount) are manufactured with polyester and glass fiber winding for dependable, durable and all weather operation. They are economic, high performance filters for private pool, fish pool, Jacuzzi and public pools.

### Features of FB filters include:

- Multi-port 6-way valve (bolts-on) with lever-action handle
- Integral sight glass for watching backwash cycle
- Manometer, air-bleed apparatus for monitoring and varing the pressure of filtration system
- Large pressure sand/water drain for rapid winterizing or servicing
- Umbrella-fold self cleaning laterals for balanced flow, backwashing and easy maintenance
- Maximum working pressure: 2.5 bars.

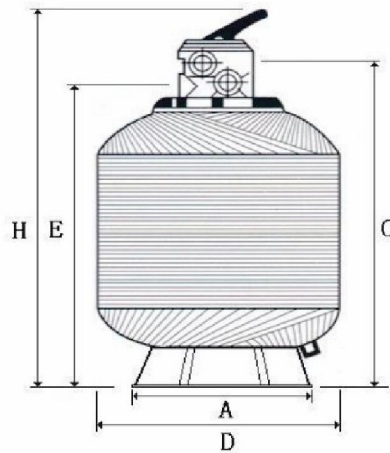

### Functions of 6-way (Multi-port) valve

1. Filter: Filtration and vacuuming
2. Waste: By pass filter, for vacuuming or draining water
3. Close: Shut off the filter system
4. Backwash: Cleaning filter by reversing water flow
5. Re-circulate: Circulating water by passing filter
6. Rinse: After backwashing to remove dirt in nozzles

REF. Model	Diameter mm	Connetction mm	Flow m <sup>3</sup> /H	Surface Area M <sup>2</sup>	Efficiency%	Sand Weight KG	Pressure KG/CM <sup>2</sup>	H MM	A MM	C MM	E MM
FB-019	450	48/50	5-7.5	0.159	75	80	2.5	815	370	640	640
FB-020	500	48/50	6-9.5	0.196	75	100	2.5	886	460	710	710
FB-021	600	48/50	9-13.5	0.283	75	180	2.5	975	460	800	800
FB-022	750	60/63	13-21	0.442	75	250	2.5	1150	590	934	934
FB-023	900	60/63	19-30	0.636	75	350	2.5	1300	790	1034	1034
FB-024	1000	75/76	24-37.5	0.785	75	450	2.5	1380	945	1164	1164
FB-025	1200	75/76	33-54.5	1.131	75	750	2.5	1580	1010	1364	1364



# FC Series - Top Mount Clamp Type

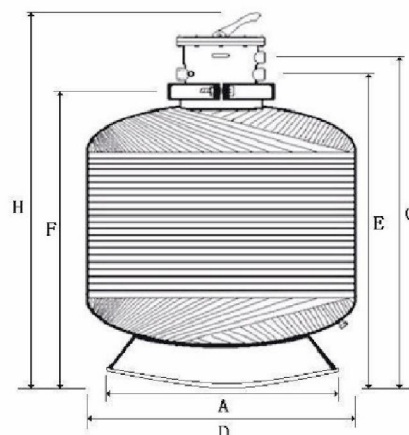

## CLAMP TYPE

*FC series (Top mount) High Performance Fiberglass Filter are manufactured with polyester and glass fiber winding for high resistance and high quality of water filtration.*

*It is economic, high performance filters for private, fish pool, Jacuzzi and public pools, equipped with*

- **Multi-port 6 way valve: filtration, backwash, rinse recycle, drain and close.**
- **Manometer, air-bleed system**
- **Stainless Steel Flange-clamp design**
- **Maximum working pressure 2.5 bars**

*Black Valves and clamps are available.*



REF.Model	Diameter mm	Connetction mm	Flow m <sup>3</sup> /H	Surface Area M <sup>2</sup>	Efficiency%	Sand Weight KG	Pressure KG/CM <sup>2</sup>	H MM	C MM	G MM	F MM	E MM
FC-018	400	48/50	4-6	0.126	75	70	2.5	723	596	350	494	560
FC-019	450	48/50	5-7.5	0.159	75	80	2.5	814	685	350	571	637
FC-020	500	48/50	6-9.5	0.196	75	100	2.5	909	780	460	645	711
FC-021	600	48/50	8.5-13.5	0.283	75	180	2.5	979	850	460	729	795
FC-022	750	68/63	13.5-21	0.442	75	250	2.5	1164	1015	580	868	939
FC-023	900	68/63	19-30	0.636	75	350	2.5	1289	1140	770	994	1065



# Six Way Multiport Valve

## Top Mount (Bolts)



**HT-715**

Model	Size
HT-715	1 1/2"
HT-720	2"
HT-725	2 1/2" ( 3")

## Top Mount (Clamps)



**HT-820**

Model	Size
HT-815	1 1/2"
HT-820	2"

### FUNCTION OF VALVE POSITION

- **FILTER** - For normal filtration, and vacuuming pool through filter.
- **BACKWASH** - For reversing flow for cleaning filter.
- **RINSE** - For initial start-up cleaning, plus re-setting filter bed after backwashing
- **WASTE** - For vacuuming directly to waste, lowering pool level / draining pool.
- **CLOSE** - For shutting off all flow to filter and pool
- **RECIRCULATE** - For by-passing filter, but circulating pool water.

## Side Mount



**HT-925**

### MP Valves' Features

- Easy-to-operate level-action handle
- Heavy-duty stainless steel spring
- High density abrasion-resistant disc key
- Molded ABS body and Cover
- Built-in sight glass for convenient backwashing viewing

Model	Size
HT-915	1 1/2"
HT-920	2"
HT-925	2 1/2" ( 3")



# Cartridge Filter



## Cartridge Elements



CF series cartridge filters offer added quality, value and convenience in cartridge filtration. With filter tanks constructed of UPVC material, they are the good choice for the most demanding applications and environmental conditions.

Plus, with a larger filtration element, these filters have greater effective filtration area than similar sized and priced cartridge filters.

### Applications

- In-ground pools or pool / spa combinations
- In-ground, in-deck or movable spa
- Above-ground pools/hot tubs
- Small or indoor fountains

### Features

- Filter tanks made of UPVC material to meet the demands of the toughest applications and environmental conditions
- Single piece injection-molded base provides added strength for reliable, corrosion-free performance
- Stainless steel clamp securely fastens head to filter tank
- Durable filter head may be rotated to conveniently position pressure gauge and manual air relief
- Extra-large cartridge element provides extra-strength and maximum flow
- 2" FIP, 2" SKT connections for plumbing versatility

### CARTRIDGE FILTER SYSTEM

The combination of KLP pumps with cartridge filters are available:

SCF25P37 – CF25 C/W KLP-37

SCF50P55 – CF50 C/W KLP-55

SCF75P75 – CF75 C/W KLP-75

SCF100P110 – CF100 C/W KLP-110

SCF125P110 – CF125 C/W KLP-110

S/S trolley are optional.



Model Number	Filtration Area Ft <sup>2</sup>	Design Flow Rate L/Min	Turnover (Liters) 8HR	Turnover (Liters) 10HR	Dimensions mm Width	Dimensions mm Height	Element Model
CF-25	25	95	45420	56775	230	500	CFE-025
CF-50	50	189	90840	113550	230	750	CFE-050
CF-75	75	284	136260	170325	230	750	CFE-075
CF-100	100	341	163512	204390	230	1280	CFE-100
CF-125	125	454	218016	272520	230	1280	CFE-125



# All-in-one Filter System



**SFB350P33 System**

**Top-mount** sand filter system are equipped to offer the ideal combination of high water clarity and energy efficiency. A broad selection of filter sizes, pumps and accessories allows you to choose the filter systems that best suit your above-ground pools.



**SFC018P55 System**

## System Features

- Systems are designed for quick assembly and precise alignment of components
- Pumps and filters are performance-matched to provide maximum flow and energy efficiency
- Filter bases Interconnect with fiberglass stand for long lasting, all-weather performance
- 6-position 1.5" multiport valve
- Combination water and sand drain makes servicing and winterizing fast and easy
- All models are one carton systems

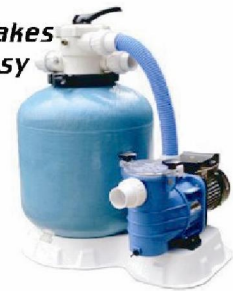

Model Number	Filter Dia. MM	Filter Control Valve	Pump	H.P.	Flow Rate m <sup>3</sup> /hr	Head M	Ctn.Qty.	Volume M <sup>3</sup>
SFB350P25	350	1.5" MPU (HT-715)	KLP25	1/3	4.5	3.0	1	0.24
SFB018P33	400	1.5" MPU (HT-815)	KLP33	1/2	6.0	5.0	1	0.24
SFB018P55	400	1.5" MPU (HT-815)	KLP55	3/4	6.0	8.0	1	0.24
SFB019P55	450	1.5" MPU (HT-815)	KLP55	3/4	7.6	5.0	1	0.34
SFB019P75	450	1.5" MPU (HT-815)	KLP75	1	7.6	10.0	1	0.34
SFB020P75	500	1.5" MPU (HT-815)	KLP75	1	9.5	8.0	1	0.34
SFB020P110	500	1.5" MPU (HT-815)	KLP110	1 1/2	9.5	13.0	1	0.34
SFB021P75	600	1.5" MPU (HT-815)	KLP75	1	13.5	5.0	1	0.49
SFB021P110	600	1.5" MPU (HT-815)	KLP110	1 1/2	13.5	8.0	1	0.49

# FI Series - Mild Steel Vessel Type

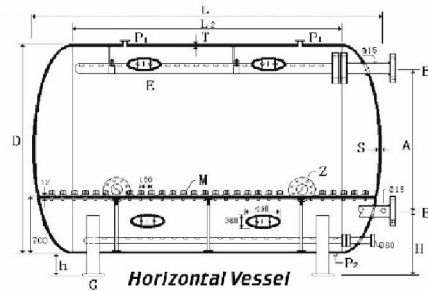

**Mild steel vessels are classified into two different types of filter. One is Vertical, and the other is Horizontal. The factory, which is located in mainland China, offers a comprehensive range of pressurized vessel. We supply products with the highest quality to the demanding requirement.**

**All our products are designed and manufactured to the B.S. standard, JIS standard, ASME standard or specified requirement. The inside wall of tank are coated by RUST-OLEUM brand in U.S. They are suitable for commercial & Residential uses.**

**Tank assemblies are completed with manholes, relief valves, flange connections, under-drains and strap legs.**

**Advantages of Steel Vessel**  
**-For high pressure filtration**  
**-Long lifespan (about 20 years)**

**Stainless Steel 304 or 316 vessels are also available.**

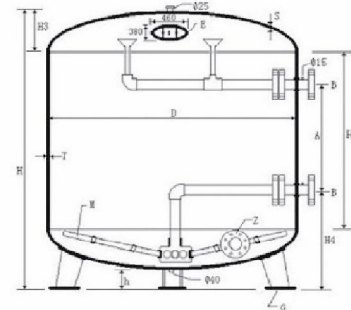
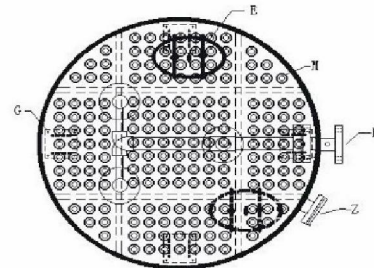

**Lateral Hub Type**

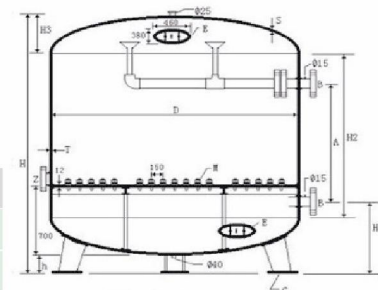

**Nozzles Type**

Tank Body Height mm - A	Nominal Pipe Bore - B	Tank Diameter mm - D	Overall Height mm	Filter Area m <sup>2</sup>	Filtration Rate m <sup>3</sup> /m <sup>2</sup> /hr	Design Flow m <sup>3</sup> /m <sup>2</sup> /hr
800	80	1000	1650	0.79	38/48	30.02/37.92
800	80/100	1200	1650	1.13	38/48	42.94/54.24
800	100	1400	1650	1.54	38/48	58.52/73.92
800	100/150	1500	1650	1.77	38/48	67.26/84.96
1000	100/150	1600	1850	2.01	38/48	76.38/96.48
1000	150	1800	1850	2.54	38/48	96.52/121.92
1000	150/200	2000	1900	3.14	38/48	119.32/150.72
1000	200	2200	1900	3.8	38/48	144.4/182.4
1000	200/250	2400	1900	4.52	38/48	171.76/216.96



# Hub and Nozzle



*Stainless Steel Hub*



*Plastic Hub*



*Stainless Steel Type*

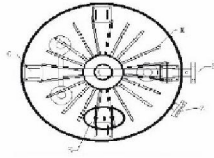

*Hubs and Nozzles*



*Easy For Installation*



*HT-N25-170 170mm(L)*

*HT-N25-100 100mm(L)*

*1" nozzle*



*HT-N40-170 170mm(L)*

*1 1/2" nozzle*

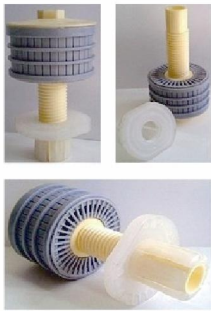

*HT-N65-50*

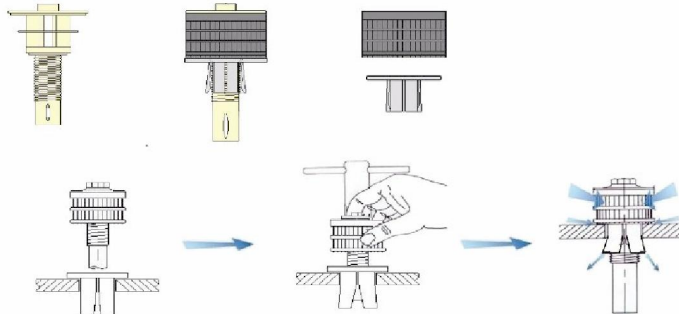

- R10001-H15-Plastic Hub 1.5"*
- R10001-H20-Plastic Hub 2"*
- R10002-H30-Stainless Steel Hub 3"*
- R10002-H40-Stainless Steel Hub 4"*
- R10002-H60-Stainless Steel Hub 6"*
- R10002-H80-Stainless Steel Hub 8"*

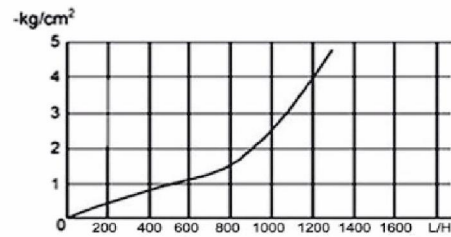

# KL and KLP Series



**KL Series**

Connected with 48mm or 50mm union



**L**



**R**



**KLP Series**

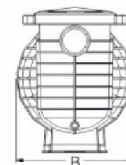
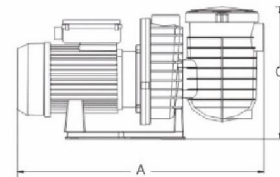
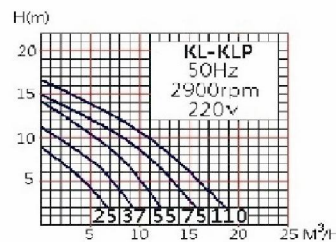

**KL and KLP series pump are low maintenance pump series for most of domestic spas, above-ground and in-ground pools requiring quiet self-priming action. These series pumps operate extremely quiet. They can be easily installed and repaired if necessary due to their special design. The outlet direction can be shifted to either left or right other than upward.**

### KL & KLP Features

1. Heavy duty motor.
2. (KLP) Durable plastic basket.
3. Graphite and pottery mechanical/seal.
4. Automatic thermal overload protector.
5. Weather protected to IP 54 grade F.
6. Pump base can be disassembled easily.
7. Stainless steel shaft.
8. Rotary type (KL) pump clear cover.
9. Exclusive corrosion-proof glass loaded polypropylene housing for all weather performance.
10. Barrel union connection for ease of installation.
11. Silent check valve applied at outlet connection.
12. Three different outlet directions alternative (Left, Right or Up).
13. Energy efficient with extremely quiet operation.

Model	Watts	Volt	HP	Amp	RPM	Inlet mm	Outlet mm	Discharge HEAD in Metres (M <sup>3</sup> /H) 5M	Discharge HEAD in Metres (M <sup>3</sup> /H) 10M	Discharge HEAD in Metres (M <sup>3</sup> /H) 12M	Length	Width	Height
KL/P-25	250	220	1/3	1.2	2800	48/50	48/50	4.2	/	/	320/460	190/235	225/280
KL/P-37	370	220	1/2	1.3	2800	48/50	48/50	6	3.6	/	320/480	190/235	225/280
KL/P-55	550	220	3/4	2.4	2800	48/50	48/50	9.6	7.2	2.8	340/480	190/235	225/280
KL/P-75	750	220	1	3.2	2800	48/50	48/50	13.8	10.2	5.4	400/540	190/235	265/280
KL/P-110	1100	220	1.5	4.5	2800	48/50	48/50	15.6	13	7.9	400/540	190/235	265/280



# KT Series



**KT Series**

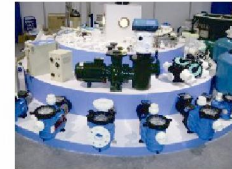
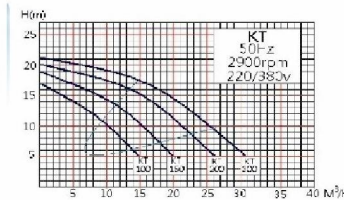
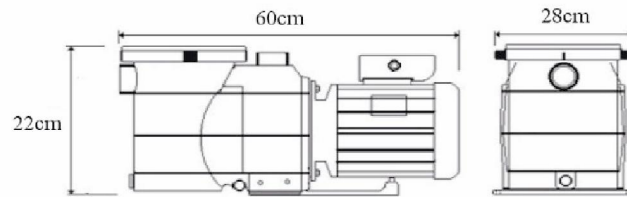

**KT series pumps are high performance, low maintenance pumps for above-ground and in-ground pools requiring self-priming action. These series pumps are extremely quiet, compact and engineered for maximum power output with low energy consumption. They are economic choice for residential pools. Extensive research and a commitment to ongoing product development ensure that KT continues to develop a wide range of innovative high quality pumps.**

**KT features including:**

- Heavy duty, ALUMINIUM casing flange motor.
- Durable plastic basket.
- High quality graphite and pottery mechanical seal.
- Automatic thermal overload protector.
- Weather protected to IP 54 grade F.
- Pump base can be disassembled.
- Stainless Steel shaft.
- Rotary clamp and clear cover.
- Exclusive corrosion-proof glass loaded polypropylene housing for all weather performance.
- Barrel union connection for ease of installation.
- Silent check valve applied at outlet connection.
- Energy efficient with extremely quiet operation.

Model	Watts	Volt	HP	Amp	RPM	Inlet mm	Outlet mm	Discharge HEAD in Metres(M <sup>3</sup> /H)5M	Discharge HEAD in Metres(M <sup>3</sup> /H)10M	Discharge HEAD in Metres(M <sup>3</sup> /H)15M	Length	Width	Height
KT-75	550	220	3/4	3.1	2800	50	50	13.0	11.5	3	545	280	295
KT-100	750	220	1	3.25	2800	50	50	14.8	13.0	6	605	280	295
KT-150	1100	220	1.5	4.8	2800	50	50	19.3	14.8	7.6	605	280	295
KT-200	1500	220	2	6.5	2800	50	50	25.2	20.8	15	605	280	295
KT-300	2200	220/380	3	7.5/4.2	2800	50	50	29.4	24.5	18.2	605	280	295





# KH Series



**KH Series**

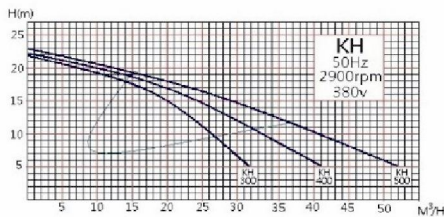
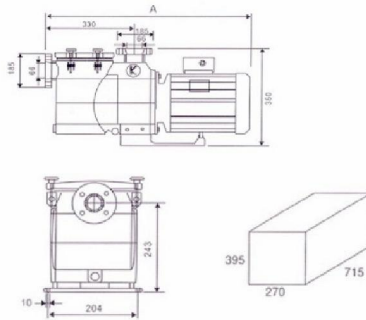

**The KH series pumps are designed for commercial pool & spas which require the pumps to give higher meter head and flow rate. These series pumps are very quiet, compact and engineered for maximum power output with low energy consumption.**

**KH Features including:**

- ⊙ **Heavy duty motor with IP 54 grade F Waterproof Standard.**
- ⊙ **Stainless steel (304) basket.**
- ⊙ **High grade mechanical seal.**
- ⊙ **Thermal overload protector.**
- ⊙ **Pump base can be disassembly.**
- ⊙ **Stainless steel shaft.**
- ⊙ **4 screws type (series KH) pump clear cover.**
- ⊙ **Exclusive corrosion-proof glass loaded polypropylene housing for all weather performance.**
- ⊙ **Energy efficient with extremely quiet operation.**
- ⊙ **2-1/2" MIP or 2-1/2/3" Flange connection.**
- ⊙ **Bigger Impeller & improved diffuser**

Model	Watts	Volt	HP	Amp	RPM	Inlet mm	Outlet mm	Discharge HEAD in Metres (M <sup>2</sup> /H) 5M	Discharge HEAD in Metres (M <sup>2</sup> /H) 10M	Discharge HEAD in Metres (M <sup>2</sup> /H) 15M	Leigth	Width	Height
KH-300	2200	380	3	4.2	2800	75	65	30.2	24.5	18	610	260	355
KH-400	3000	380	4	5.7	2800	75	65	41.7	32.9	20	645	260	355
KH-500	4000	380	5	6.8	2800	75	65	50.1	37.5	25.8	670	260	355



# KRF Series

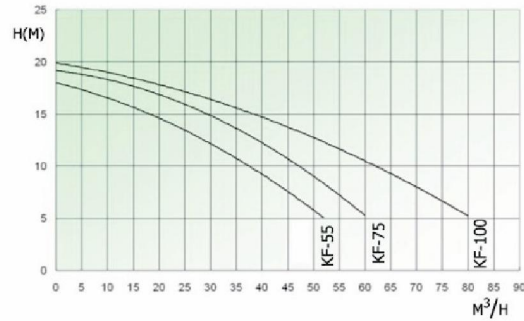

**KRF series pumps are commercial use high performance centrifugal pump. KF can be used either in 6" (inlet) 4" (outlet) or 4" (inlet) 4" (outlet).**

**The pump unit is painted with high quality enamel paint. The standard unit is supplied with 380V, 2800 rpm, 50HZ, 3 phases.**

**Materials of the pump parts:**

- **Pump casing, impeller and strainer in cast iron**
- **Basket, mechanical seal and shaft in stainless steel.**
- **Motor available either in aluminium or cast iron.**

Model	Watts	Volt	HP	Amp	RPM	Inlet mm	Outlet mm	Discharge HEAD in Metres (M <sup>3</sup> /H) 5M	Discharge HEAD in Metres (M <sup>3</sup> /H) 10M	Discharge HEAD in Metres (M <sup>3</sup> /H) 12M	Sand Filter Dia. (mm)
KRF-55	4000	380	5.5	5.8	2800	100	100	44	40	36	1400
KRF-75	5500	380	7.5	7.8	2800	100	100	56	53	47	1500
KRT-100	7500	380	10	10.5	2800	100	100	72	64	58	1600

# ADVAN CHLOR

## SALT WATER TREATMENT SYSTEMS



Time

SAVE

Money



Model:AC24-AC30



Model:AC12-AC20



# Salt Chlorinator

**ADVAN CHLOR is a high efficiency salt chlorination system that let you enjoy sparkling clear pool water without toxic chemical. The process of chlorine production by salt chlorination system (Advan Chlor) is known as Electrolytic Generation. This process simply produces chlorine from a small amount of salt that is added to your pool water.**

**ADVAN CHLOR comprises with 2 mainly components that are electronic power supply which controls the operation of the system, and electronic cell which connects easily to standard pool circulation system.**

### ADVAN CHLOR Advantage

- ⊙ Eliminates purchase cost of expensive chlorine sanitizer
- ⊙ Inexpensive natural salt (Sodium Chloride-NaCl) is added to the pool water
- ⊙ The saline solution is passed through an electrolytic cell installed in the pipe work near the filtration system
- ⊙ Chlorine is manufactured in the cell by the electrolysis of the saline solution
- ⊙ Eliminates the storage & handling of dangerous chlorine
- ⊙ Reduces the commercial manufacture of chlorine so is environmentally friendly
- ⊙ Fully automatic... makes chlorine when the filtration system operates
- ⊙ Approximately the same salinity as a tear drop... soothing to eyes and skin
- ⊙ Produces sanitized, sparkling, healthy, clear pool water
- ⊙ Non-corrosive to all pool surfaces

### ADVAN CHLOR Features

- ⊙ Large cell housing for high flow rates
- ⊙ Battery back-up for time/clock adjustment
- ⊙ 7 days timing setting, 10 times on/off setting per day
- ⊙ Digital Display & LED indicator
- ⊙ UV & waterproof cabinet
- ⊙ State of the art electronic technology
- ⊙ water flow detection device
- ⊙ 10-100% chlorine output function

**The ADVAN CHLOR system is suitable for Residential and Commercial applications by choice of models available. Contact your local pool equipments suppliers for detail.**

Model	Voltage in (v)	Max Amp	DC Out	Current Range (A)	Pool Vol. (M3)
AC-12	220/240	13	28	2.8-3.2	30-60
AC-15	220/240	13	28	3.5-4.6	40-75
AC-18	220/240	13	28	4.5-5.2	50-90
AC-20	220/240	13	28	6.2-8.5	60-100
AC-24	220/240	5	28	8.5-10.0	70-120
AC-30	220/240	5	28	10.5-12.8	80-150

# Electrical Six-Way Multiport Valve



**Model:TH-228**

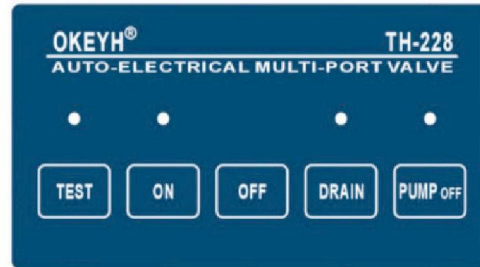

**Control Board**

***Six-Way MultiPort valve, designed for fully automatic and cost-efficient centrifugal filter systems.***

***Application include Swimming Pool, Spa, Fish pond, Water Treatment Systems, Trick Fountains and cooling***

## ***Features:***

- Backwash Procedure can be controlled by pressure or timer setting automatically.***
- Available for 1.5" and 2" valves (Either Top-Mount and Side-Mount)***
- Connect with pump directly.***
- Quick and Easy installation.***
- Quick conversion without any additional tools and dismantling of the valve from automatic to manual override.***
- Four Procedure would be controlled by programming (Filter, Backwash, Rinse, Waste)***
- Pressure Data and Backwash Time would display on LED Digital Board.***
- Easy Setting Backwash Time, Rinse and Delay Time on Potentiometer Knob.***
- Functional usage in control Centrifugal Pump (Below 2HP), Heater and Associated Ball / Butterfly Valves.***





# **ORP/PH/Temp Digital Controller**



**Model:TH-200**

## **Features:**

- Easy to Install.**
- Simple to Operate.**
- Available for Fish Industries.**
- Clear Panel with all Functions.**
- Adjustable Alarm.**
- Overload Protection.**
- Waterproof Cabinet.**

**TH-300 is optional model for PPM/ Ph/ Temp Digital Controller**

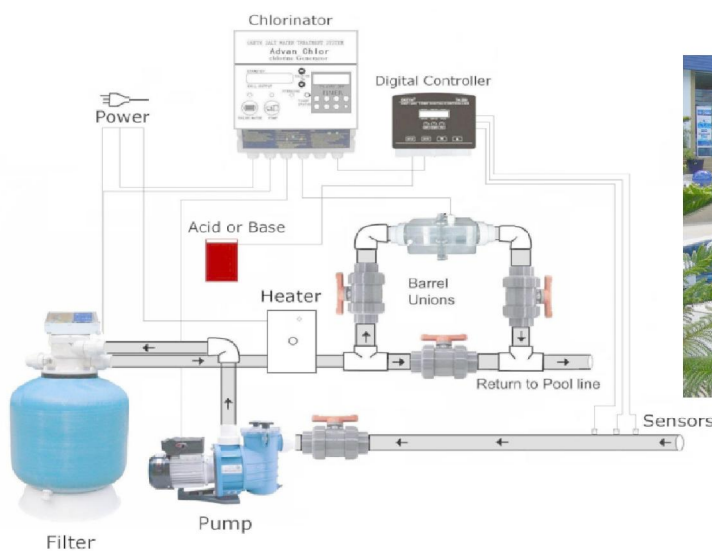

# Wall Mount Pool Skimmer

## TH-1083 skimmer

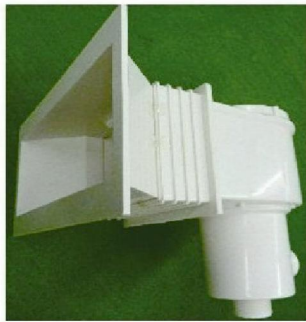
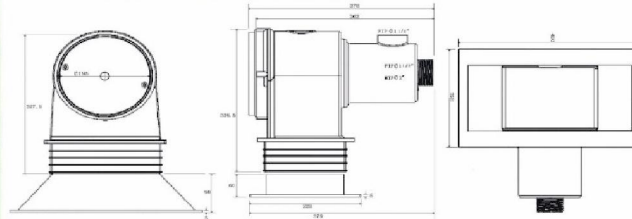
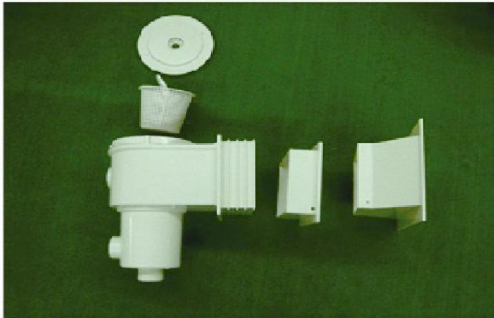

### Features:

- High Strength ABS made
- Adjustable lid extension collars
- Big enough strainer basket
- Handy Vacuum Plate
- Selection of throat lengths
- Selection of pipe-connect direction (exclusive feature)



### Multi-Skim

**TH-1082 skimmer offers a multi-function skimmer for all plumbing and construction requirements, configuration and materials.**

### Advantages

- High Strength ABS made
- Adjustable lid extension collars
- Big enough strainer basket
- Handy Vacuum Plate
- Selection of throat lengths

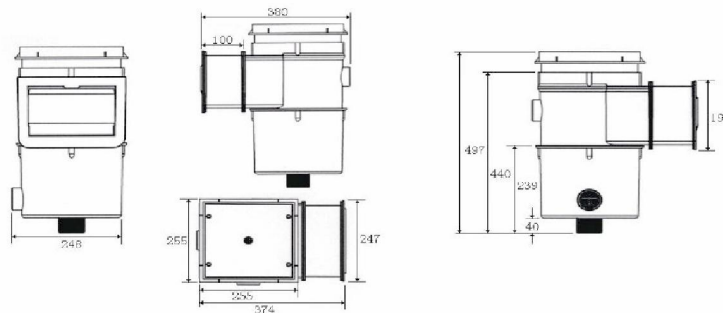



# Pool Fittings Accessories and Drains



**1019 Gutter**  
Attractive and Streamlined  
HT-1019 2" FIP plus 2" socket  
connection when white body  
and grate

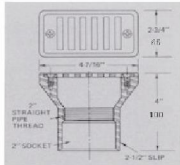

**Optional Models**  
HT-1019N48(SKT 48MM)  
HT-1019N50(SKT 50MM)  
HT-1019N60(SKT 60MM)  
HT-1019N63(SKT 63MM)



**Square Frames & Grates**  
HT-1031 9" x 9"  
HT-1032 12" x 12"  
HT-1033 18" x 18"

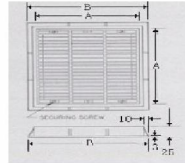

**Vacuum Fitting**  
HT-1022 1.5" FIP white



**Flush Plug**  
HT-1022B 1.5" Plug,white

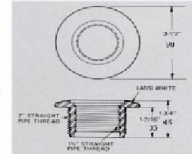

**Round Frames & Grates**  
HT-1030 7 3/4" dia, white, with securing screws

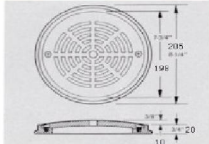

**Outlet Fitting Grate Insert**  
HT-1026 1.5" MIP  
Install in any 1.5" FIP  
Wall outlet



**Directional Flow Inlet Fitting Hydrostream**  
HT-1419 1 1/2" MIP  
HT-1419N(48MM/50MM socket)  
HT-1419B OR BN (10MM opening)  
HT-1419C OR CN (15MM opening)  
HT-1419D OR DN (20MM opening)



**Hydrostream Insider Fitting**  
HT-1421 1" SKT X 1 1/2" SKT)  
HT-1421B(10mm opening)  
HT-1421C(15mm opening)  
HT-1421D(15mm opening)



**Wall Inlet (eye ball), White**  
HT-1519W1, SKT 48MM OPENING 15mm  
HT-1519W2, SKT 50MM OPENING 20mm



**Vacuum fitting with plug White**  
HT-1522W1 SKT 48mm  
HT-1522W2 SKT 50mm



**Floor Inlet adjustable, white**  
HT-1525W1 Eye ball SKT 48mm  
HT-1525W2 Eye ball SKT 50mm



**Grate Insert as wall outlet**  
HT-1526W1 Eye ball SKT 48mm  
HT-1526W2 Eye ball SKT 50mm



HT-1424S Inner:48mm



HT-1424SM Inner:50mm



HT-1424A 1.5" FIP x 2" MIP



HT-1424SB Outer:59.5mm



**Commercial ABS Main Drain SP-1062**  
A full size, non-corrosive and non-conductive main drain.  
ABS body, 9" x 9" Square Frame and Grate (HT-1031B Grate)  
Side Outlet 1.5" FIP, Bottom outlet 1.5" FIP X 2" MIP



HT-1424, HT-1525 Wall and Floor Inlets  
-White Body and grate  
-Flow adjustment

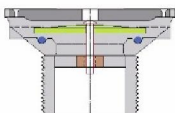
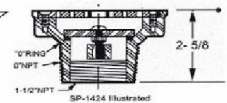

HW-1625

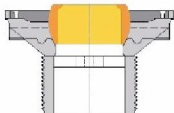

HW-1619

## new models

Standard: 3" MIP X 2" SKT (60mm)  
Alternative: 2 1/2" SKT X 2" SKT (63mm)





# Pool Fittings - Jet Air Nozzle



HT-1434



HT-1439

**HT-1434 and HT-1439 Adjustable Jet-Air system offer interchangeable jet nozzles, allowing for multiple configuration options to achieve the type of hydro massage action you want, where you want it.**

**And with adjustable Jet-Air system, you can control the water and air flow right at the jet face.**

- Features**
- **Air Supply access for optional 1/2" vertical air tube (if desired) for individual fitting.**
  - **Body Housing has PVC full-flo combination air and water connection for easy, efficient manifolding. 6/8" and 1 1/2" size.**
  - **Adjustable Jet Nozzle is fully recessed and let you easily adjust water flow and jet intensity at each fitting.**
  - **Swivel Ball Assembly allows you to individually direct the water and air flow. Ball Seals and Lock Ring hold ball securely in place and gives smooth operation**
  - **while allowing for easy removal of ball/jet assembly from inside spa for future cleaning or service.**
  - **Bulkhead fitting threads securely into main body housing to provide an attractive, dependable compression seal on spa wall.**

Model	Description
HT-1434PAKA1	body 1 1/2" air x 1 1/2" water (48x48mm)
HT-1434PAKA2	body 1 1/2" air x 1 1/2" water (50x50mm)
HT-1434PAKA3	body 6/8" air x 1 1/2" water (26x48mm)
HT-1434PAKA4	body 6/8" air x 1 1/2" water (25x50mm)
HT-1439PAKA1	body 4/8" air x 1 1/2" water (48mm)
HT-1439PAKA2	body 4/8" air x 1 1/2" water (50mm)
HT-1434PAKB	Fully adjustable and directional nozzle

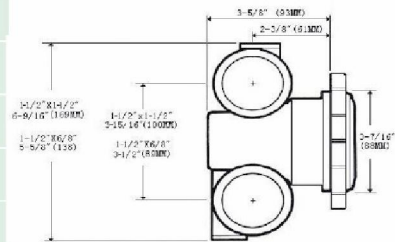

SS-1424



SS-1022



**HT-503 Stainless Steel**  
HT-501A/B 1 1/2"  
HT-501A/B 2"  
HT-501A/B 3"



**Shower**  
HT-5011



# PVC Pipe Fitting



**Bulkhead Fitting**



**Pump Check Valve**



**2-way Valve Union  
(straight)**



**PVC Union  
Range: 1.5" and 2"**



**2-way Ball Valve  
Range: 1.5"-4"**



**Butterfly Valve  
(Handle Lever Type)  
Range: 3"-8"**



**90 Degree Elbow  
Socket**

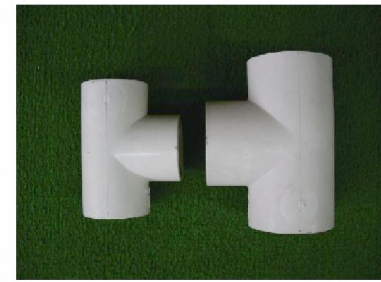

**Tee Socket**



**vacuum hose adaptor**

**VH-WS  
(plug in  
1.5" and 2"  
inch easily)**



**Flexible Joint**

**WT-SK15  
(1.5")  
WT-SK20  
(2")**

# Pool Plastic Grating

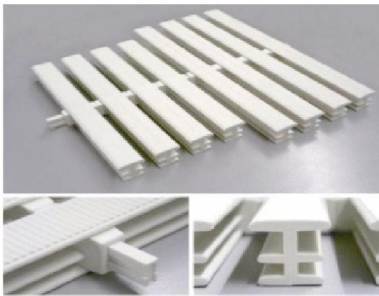

**Model: HTS-2525**

**Features:**

- Coupling unit for adjustment between modules.
- Loose Pressure-joint module.
- 31 units per meter.
- Buyer could choose different width as their need.

**Range: 300mm – 150mm**

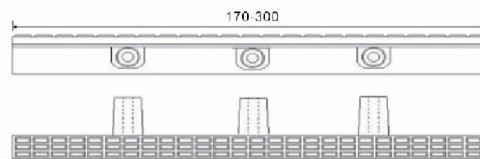

**Model: HT-E300**

**Features:**

- Coupling unit for adjustment between modules
- Colour Options: Gray, Red, Blue, Apricot, Black, Beige
- Buyer could choose different width as their need.

**Range: 170-300mm**

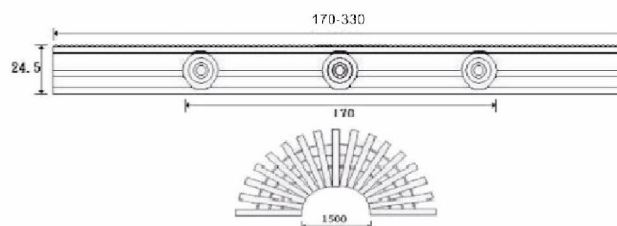

**Model: HT-E330**

**Features:**

- Coupling unit for adjustment between modules
- Colour Options: Gray, Red, Blue, Apricot, Black, Beige
- Buyer could choose different width as their need.

**Range: 170-330mm**





# Pool Accessories



**HT-201**  
**14" Economy Flexible Vacuum Head.**  
 14" low profile with 4 weights under plastic covers. Spring loaded snap-adapt handle, stainless steel hardware and adjustable wheels.



**HT-2001&HT-718**  
**HT-2001 18" Aluminum Back Wall Brush with nylon bristles.**  
**HT-718 18" Aluminum Back Stainless Steel Algae bristles.**



**HT-2002&HT-712**  
**HT-2002 12" Aluminum Back Wall Brush with nylon bristles**  
**HT-712 12" Aluminum Back Stainless Steel Algae bristles.**



**HT-2012&HT-2011**  
**HT-2011 18" Plastic Back Wall Brush with nylon bristles.**  
**HT-2012 12" Plastic Back Wall Brush with nylon bristles.**



**HT-B30**  
 This ring buoy features a completely waterproof, non absorbent, closed-cell inner core and is equipped with poly-proylene grab lines



**HT-402**  
**Econo Leaf Rake. White molded frame with reinforced aluminum. Raised lip. Gray/ Blue fiberglass net.**



**HT-1245**  
**Leaf Skimmer. Polyester screen molded into polypropylene frame. Complete with magnet. Fits 1 1/4" poles.**



**HT-1255**  
**Leaf skimmer with durable plastic frame & nylon net**



**HT-1245R**  
**Leaf skimmer with Al handle & nylon round-hole net**



**Telescopic Poles Metal Cam (M) / Plastic Cam (P) with Anti-skid Groove (G) / Smooth Handle (S)**

**HT-3700: 2m to 3.7m**  
**HT-4700: 2.5m to 4.7m**  
**HT-6700: 3.5m to 6.7m**  
**HT-7700: 4.0m to 7.7m.**



**Vacuum Hose**  
 \* Light weight, durable, crush and kink resistant  
 \* Highly flexible with swivel  
 \* UV resistant  
**Model**  
**VHC1520-1560B ..... 1.5" X 20' to 60' length, single layer, blue**  
**VHS1520-1560BB ..... 1.5" X 20' to 60' length, dual layer, blue black**  
**VHE1520-1560WB ..... 1.5" X 20' to 60' length, dual layer, white black**



# Pool Accessories



**HT-127 Tube Thermometer**  
Molded ABS tube body.  
Thermometer has F and C  
scale in sealed glass tube.  
3' polyethylene cord.



**HT-130 Chrome Thermometer**  
Body molded of ABS with electro  
chrome plated finish. 2'  
polyethylene cord.



**HT-133 Floating Thermometer**  
ABS tube case with flotation cap.  
F and C scale in sealed glass tube.



**FD 303**      **FD 301**  
**FD 015**  
**Chemical Dispensers**



**KCL-220**      **KCL-200**  
**Chemical Feeders**

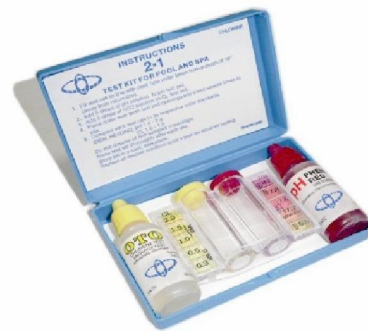

**HT-752 "2 in 1" High Range Test Kit**  
The blue-hinged case with special  
clasp opens and close securely.

Contains 3/4 oz Phenol Red with  
pre-blended neutralizer and 3/4 oz OTO.

Stand up test block, waterproof  
instruction card and full color 12  
packs counter display. PH ranges  
6.8-8.2 CL ranges 0.3-3.0.

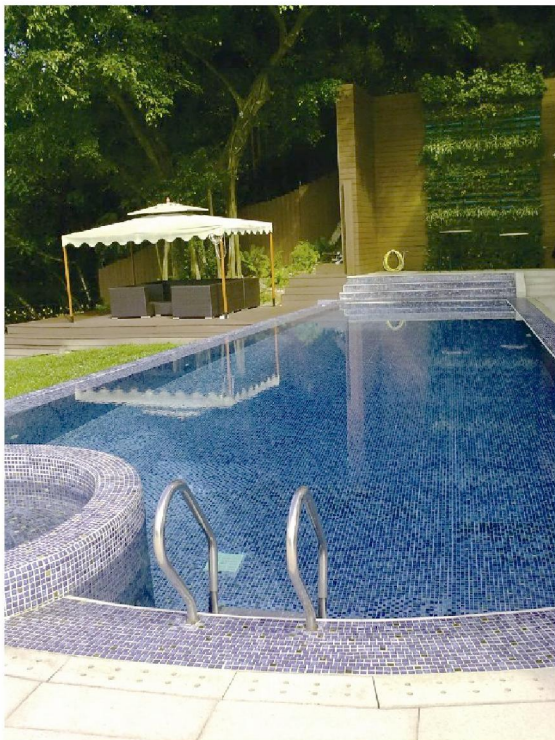



# Pool Racing Lane and Float Ball



**Model: HT808 Helix Groove Handy Lock Float**  
 The Helix Grooves on the floats give the anti-wave ability for the floats, which can be handily locked on the rope. Four colors of Helix Groove Handy Lock Floats are available: Red, Blue, Orange, and White. There are more combinations of the floats for users' choices.

The inside diameter of float are provided to accommodate 3/8" or 10mm polypropylene rope.

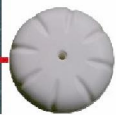
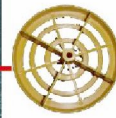
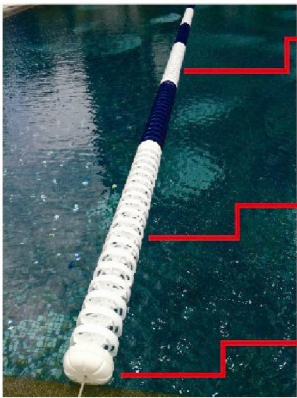

**Competitive Racing Lane interlocking discs stop the wave's lateral movement and divert the force along the length of the lane. The cable is 304 stainless steel. The tension reel can be SUPERTENSIONER or Competitor Ratchet Take Up Reel.**

**Model:**  
 HT-RL425 Anti-wave racing lane 25M with 4" disc.  
 HT-RL450 Anti-wave racing lane 50M with 4" disc.  
 HT-RL625 Anti-wave racing lane 25M with 6" disc.  
 HT-RL650 Anti-wave racing lane 50M with 6" disc.



HT-49 Super Tensioner for racing lane



HT-47  
 Chrome plated bronze for 5/8" and 3/4" rope



HT-45  
 Chrome plated bronze for 3/8" and 1/2" rope



S Hooks



HT-380  
 Flexible Floats  
 size:70mm\*65mm  
 colour:red



HT-80535R 3"x5" Red/White/Red  
 HT-80535B 3"x5" Blue/White/Blue  
 HT-80535Y 3"x5" Yellow/White/Yellow

Model: HT Handy-Lock Floats are made of linear polyethylene treated with chlorine inhibitors and UV stabilizers for durability and long life

# Starting Block and Pool Ladder

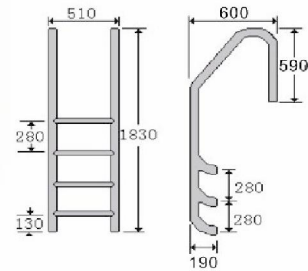
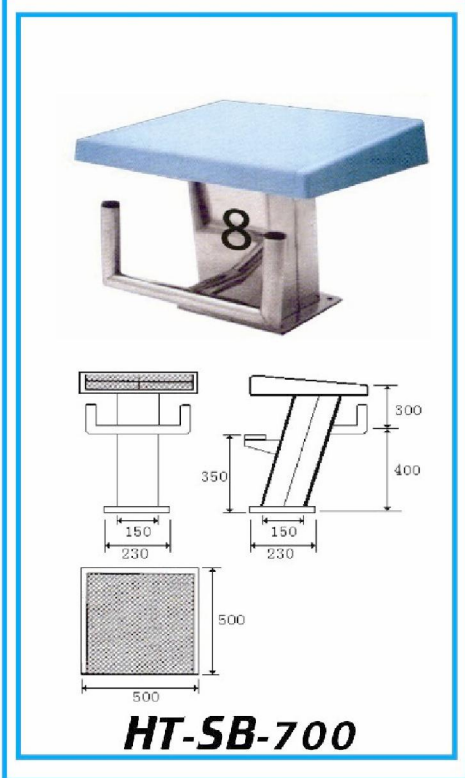
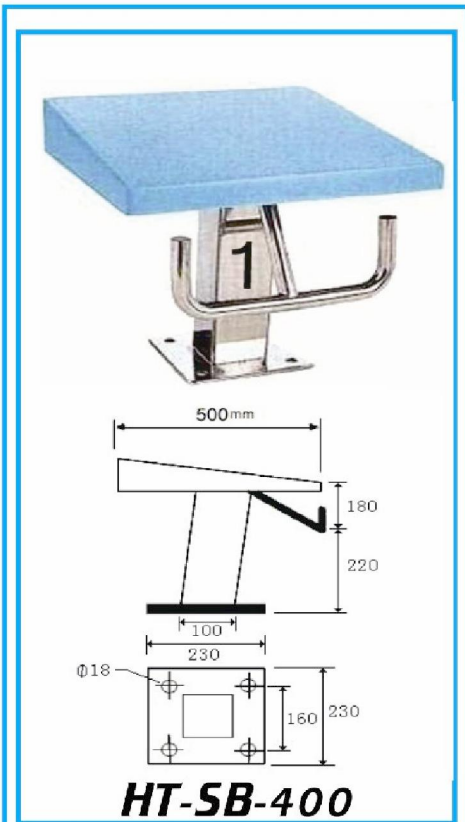

**Commercial Ladder**  
**HT-SL215(2 treads)**  
**HT-SL315(3 treads)**  
**HT-SL415(4 treads)**  
**HT-SL515(5 treads)**

**Pipe dia. 50mm(optional)**

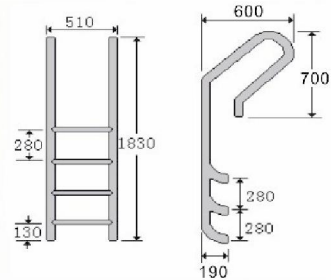

**Futuristic Ladder**  
**HT-SF215(2 treads)**  
**HT-SF315(3 treads)**  
**HT-SF415(4 treads)**  
**HT-SF515(5 treads)**  
**Pipe dia. 50mm(optional)**

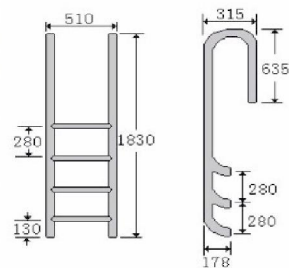

**ECHELLE Ladder**  
**HT-SU215(2 treads)**  
**HT-SU315(3 treads)**  
**HT-SU415(4 treads)**  
**HT-SU515(5 treads)**  
**Pipe dia. 50mm(optional)**



# ***Stainless Steel Life Guard Chair and Take Up Reel***



***Life Guard Chair for Standard Pool  
Model:HT-LGC-200-R***



***Stainless Steel Take up Reel  
Model:HT-1300***



***Type C Life Guard Chair  
Model:HT-LGC-50-R***



***Removable Life Guard Chair  
Model:HT-LGC-150-R***





# Wall Mount Pool Light

*Pool Light recessed swimming pool luminary without transformer, for concrete plastic sheet, metal or plastic pool with:*

- 1 low voltage reflector lamp*
- PAR 56, 12V, 100W 200W 300W, 14°/40°*
- 12V AC/DC, 15W-40W LED*
- Protection Class IP68 3M*
- Electro-polished stainless steel*
- 3-30M waterproof cable*
- Safety Class III*



**PAR56**



**PAR 36**

*Recommended installation depth is 500-700mm below water level. The luminary may only be operated underwater.*



**PL-300**

**PL-100**

**PL Series** 100W, 300W 12V  
(with ss face ring, installed with niches)

- PAR36:**  
 PL10005.....100 watt, 12 volt, 5M cord  
 PL10010.....100 watt, 12 volt, 10M cord  
 PL10015.....100 watt, 12 volt, 15M cord

- PAR56:**  
 PL30005.....300 watt, 12 volt, 5M cord  
 PL30010.....300 watt, 12 volt, 10M cord  
 PL30015.....300 watt, 12 volt, 15M cord  
 PL30030.....300 watt, 12 volt, 30M cord



chromplated face ring (optional)  
**PLP series** .300W 12V  
 (Plastic face ring, installed with niches)

- PLP30005.....300watt, 12volt, 5M cord  
 PLP30010.....300watt, 12volt, 10M cord  
 PLP30015.....300watt, 12volt, 15M cord  
 PLP30030.....300watt, 12volt, 30M cord



provides brilliant double contact halogen quartz lighting for spas and vinyl liner pools  
 uses a mounting hub instead of a niche  
 eliminates costly make-up panels

- PS series**  
 PS10005.....100watt, 12volt, 5M cord  
 PS10010.....100watt, 12volt, 10M cord  
 PS15005.....150watt, 12volt, 5M cord  
 PS15010.....150watt, 12volt, 10M cord



**pvc Niches**

- PLN-2500**  
 Large PVC Niche  
 Compactible with  
 7843xxxx and SP581/2
- PLN-1500**  
 Small PVC Niche  
 for PL/PLP300XX  
 fixture

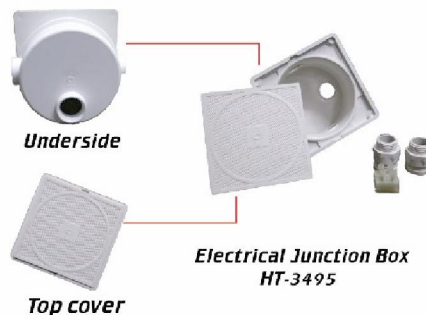

Underside

Top cover

Electrical Junction Box  
 HT-3495



Underwater circuit box (water use)



# LED Pool Light and Fountain Light Series



**LED (Light Emitting Diode) is a type of semi-conductor diode that emits light when current passes through it. Our LED Series is formed by gathering a number of LED that are controlled by integrated circuits on a circuit board. It is suitable for fish ponds, pools and fountain**

**Features:**

- Voltage(AC/DC): 12V/24V
- Energy Saving.
- Stability and Safety.
- Lifespan typically: 25,000 hours
- Watt: 7, 14, 21, 28Watt
- Cord Length: 5-30 Meters

**Model Available:**

- PL-30005 to PL-30030,
- PLP30005 to PLP30030,
- PS10005 to PS15010



- FL-B07005....12V 70W, 5M cord(35W x 2)
- FL-B10005....12V 100W, 5M cord(50W x 2)
- FL-B15005....12V 150W, 5M cord(50W x 3)

**Halogen Bulbs**

**Cast bronze construction fountain light  
Clear lens, tripod stand also available**

**Features:**

- Color of LED bulb could have many options such as red, yellow, green, blue and white. However every light can only install same colour bulb only.
- Waterproof and circuit leak-proof & corrosion resistance.
- Low power consumption.
- High Luminous Intensity.

FJ-001



FQ-322



FJ-002



FJ-003



FQ-323

**LED**

**Technical Data**

**Voltage (AC/DC):12V/24V**

**IEC Protection: IP68**

**Insulation Class A**

**LED Life Typically:20000 hours**

**Watt:3-10 watt**

**Cord Length:2.5M**



# Jumping Jet Fountain HT-950

- \* Unusual water effects
- \* Precise and glass-clear water jets
- \* Spectacular integrated light-effects
- \* Silent and vibration free
- \* Virtually maintenance free, easy to clean
- \* High safety standard, even without anchorage
- \* High-grade stainless steel, unique and compact construction
- \* Fast and easy to mount
- \* Stainless steel case with chemical treated surface, better resistance to erosion
- \* Low voltage high luminous light source
- \* Light colours including red, yellow, blue, purple and compound colours
- \* Stable shape of water jet, clear and limpidity.

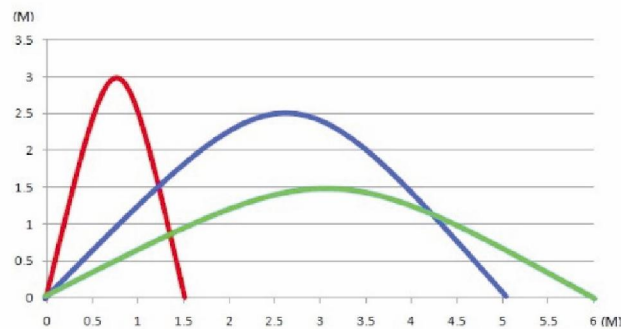

*A rod of water jets in parabolic form, Precisely aimed to disappear into a small catch hole in the ground. In the next moment it shoots up again but with a totally different jet configuration.*

*The Transparent parabolic jet is either continuous, or precisely cut into sections of various lengths.*

**Pump rated voltage.....220volt/50Hz**  
**Lighting rated voltage.....12volt AC**  
**Lighting power consumption....75watt**  
**Jet diameter.....18mm**  
**Vertical swivel range.....45-90°**  
**Material.....Stainless steel**  
**Model No.....HT-950**

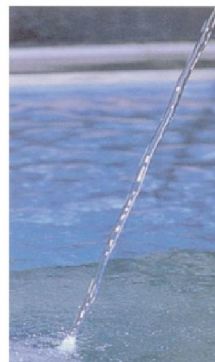

*Light beam in aspout of water, like a optical fibre*



# Fountain Nozzle

- Single Jet Nozzles**
- Independent from water level**
- Clear, wind stable and full stream jet**
- With ball and socket joint**
- With flow regulator**

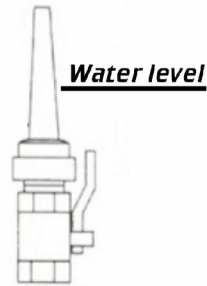

Code Model	Connect	Pressure KG/CM <sup>2</sup>	Flowrate m <sup>3</sup> /h	Height(m)
8110 ZWB 50	2"	2	5.0-8.8	3-8
8111 ZWB 40	1.5"	1.5	3.0-6.0	3-7
8112 ZWB 25	1"	1.51	2.0-4.0	3-6
8113 ZWB 20	3/4"	1.52	1.0-3.0	1-5
8114 ZWB 15	1/2"	1.53	0.3-1.5	1-4
8115 ZWB 10	10mm	1.54	0.1-1.0	1-3
8116 ZWB 8	8mm	1.55	0.1-0.5	1-2

## Multi-jet Nozzle

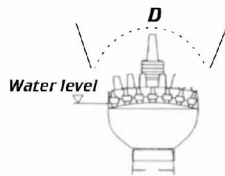
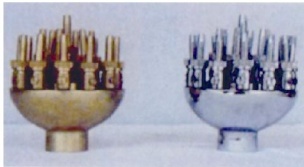

- Multi-stepped water pattern**
- Independent from water level**
- With flow regulator**

Code Model	Connect	Pressure KG/CM <sup>2</sup>	Flowrate m <sup>3</sup> /h	Height(m)	Dia(m)
8140 SKST 50	2"	0.5	22.0	2.8	2.8
8141 SKST 40	1.5"	0.5	18.0	2.5	2.5
8142 SKST 25	1"	0.5	2.0	2.3	2.3



## 1-Layer Mushroom jets

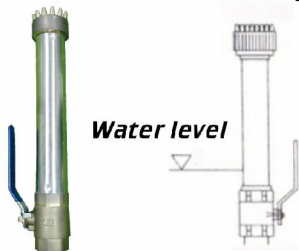

Code Model	Connect	Pressure KG/CM <sup>2</sup>	Flowrate m <sup>3</sup> /h	Height(m)	Dia(m)
8170 SYVB 40	1.5"	1	3.8-6.8	0.5-1.5	1-3
8171 SYVB 25	1"	1	2.2-3.8	0.4-1.2	1-2

# Fountain Nozzle

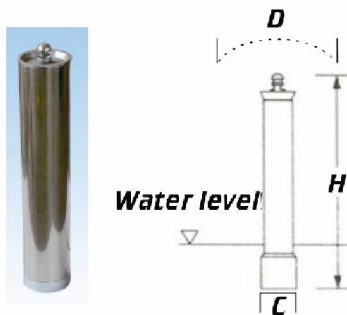

Code Model	Connect	Pressure KG/CM <sup>2</sup>	Flowrate m <sup>3</sup> /h	Height(m)	Dia(m)
8190 MLBB 100	4"	0.2	28.0	0.55	2.2
8191 MLBB 80	3"	0.2	18.0	0.50	1.6
8192 MLBB 50	2"	0.1	7.0	0.50	1.5
8193 MLBB 40	1.5"	0.1	4.0	0.40	1.0
8194 MLBB 25	1"	0.8	3.0	0.25	0.6
8195 MLBB 20	3/4"	0.8	2.0	0.25	0.5
8196 MLBB 15	1/2"	0.8	1.0	0.20	0.3



## Tulip nozzles

- Produce a clear, tulip pattern
- Little sound or splash
- Ideal for indoor or wind-free displays
- Independent from the water level

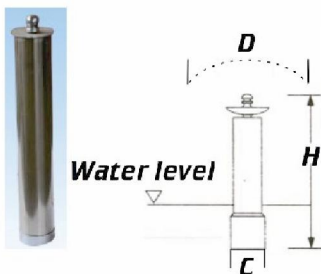

Code Model	Connect	Pressure KG/CM <sup>2</sup>	Flowrate m <sup>3</sup> /h	Height(m)	Dia(m)
8200 MMGB 100	4"	1	23.0	0.50	2.2
8201 MMGB 80	3"	1	18.0	0.50	1.5
8202 MMGB 50	2"	0.7	5.0	0.50	1.2
8203 MMGB 40	1.5"	0.5	3.0	0.40	1.0
8204 MMGB 25	1"	0.5	2.0	0.25	0.6
8205 MMGB 20	3/4"	0.4	1.5	0.25	0.5
8206 MMGB 15	1/2"	0.4	1.0	0.20	0.3



## Water film nozzles

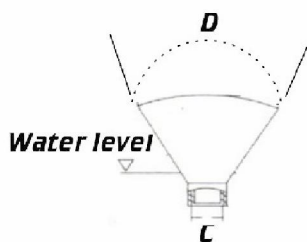

Code Model	Connect	Pressure KG/CM <sup>2</sup>	Flowrate m <sup>3</sup> /h	Height(m)	Dia(m)
8210 MSGB 50	2"	0.8	15-25	0.6-1.3	1.0-2.2
8211 MSGB 40	1.5"	0.8	10-18	0.5-1.0	0.8-1.5
8212 MSGB 25	1"	0.8	4-8	0.3-0.8	0.6-1.2
8213 MSGB 20	3/4"	0.5	2.5	0.2-0.6	0.1-0.8





# Fountain Nozzle

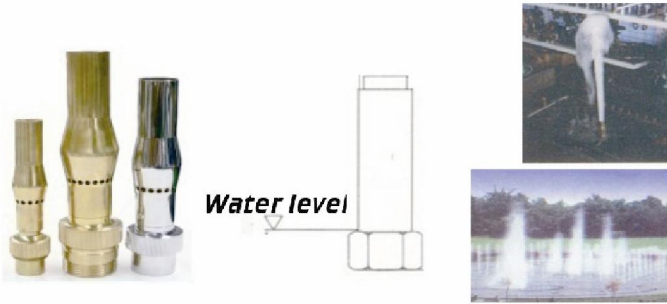

Code Model	Connect	Pressure KG/CM <sup>2</sup>	Flowrate m <sup>3</sup> /h	Height(m)
8220 CYZB 40	1.5"	2.9	15-20	2.0-5.0
8221 CYZB 25	1"	2.5	8-15	1.5-4.0
8222 CYZB 20	3/4"	1	4-9	1.0-3.0
8223 CYZB 15	1/2"	1	2-4	0.5-2.0

**Foam effect nozzles, water level dependent**  
**-Slender, white foaming water pattern**  
**-Mostly cylindrical form**  
**-Rich air mixture**



Code Model	Connect	Pressure KG/CM <sup>2</sup>	Flowrate m <sup>3</sup> /h	Height(m)
8230 CCQB 50	2"	2.5	15-20	0.8-1.2
8231 CCQB 40	1.5"	2	10-15	0.6-1.0
8232 CCQB 25	1"	2	6-12	0.5-0.8
8233 CCQB 20	3/4"	1.5	3-5	0.3-0.5



Code Model	Connect	Pressure KG/CM <sup>2</sup>	Flowrate m <sup>3</sup> /h	Height(m)
8240 CBTB 80	3"	4.5	21-50	1.0-12.0
8241 CBTB 50	2"	4	12-25	1.0-10.0
8242 CBTB 40	1.5"	3.3	8-20	1.0-8.0
8243 CBTB 25	1"	2	6-10	1.0-6.0
8244 CBTB 20	3/4"	2	2-4	1.0-4.0
8245 CBTB 15	1/2"	1.5	1-2.5	1.0-2.5

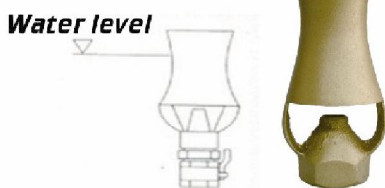

**Foam effect nozzles, water level dependent**  
**-Rich air mixture**  
**-Effective water saving**



# Fountain Nozzle

**Foam effect nozzles, water level dependent**

**-White spring water pattern  
-Luminizing with underwater light**

Code Model	Connect	Pressure KG/CM <sup>2</sup>	Flowrate m <sup>3</sup> /h	Height(m)	Dia(m)
8250 CGPB 80	3"	2	25-40	0.5-1.0	0.5-0.7
8251 CGPB 50	2"	1.5	17-25	0.4-0.8	0.3-0.6
8252 CGPB 40	1.5"	1	10-18	0.4-0.8	0.3-0.5
8253 CGPB 25	1"	1	3.5-8	0.3-0.5	0.2-0.4
8254 CGPB 20	3/4"	1	2-5	0.2-0.4	0.2-0.3
8255 CGPB 15	1/2"	1	1.5-3	0.2-0.3	0.1-0.2

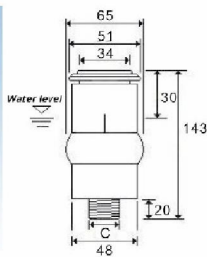

**Foam effect nozzles, water level dependent**

Code Model	Connect	Pressure KG/CM <sup>2</sup>	Flowrate m <sup>3</sup> /h	Height(m)	Dia(m)
HT-35-10E	1"	1.5	3-8	0.25-2.5	1.0-2.5



**2 layer mushroom nozzles**



Code Model	Connect	Pressure KG/CM <sup>2</sup>	Flowrate m <sup>3</sup> /h	Height(m)	Dia(m)
8300 FYGB 40	1.5"	1.5	3-8	0.5-1.5	1.0-2.5
8301 FYGB 25	1"	1.5	2-6	0.4-1.2	1.0-2.0
8302 FYGB 20	3/4"	1	2-4	0.4-0.8	1.0-1.5
8303 FYGB 15	1/2"	1	1.5-2.5	0.3-0.6	0.8-1.0





## Brass Curtain Fountain Nozzle



**Curtain nozzle and lace holder, consisting of nozzle body, lower body washer & upper slip on lock ring, all made of brass. The nozzle body has a UNF 0.375" x 24 TPI thread.**

**The nozzle body is normally threaded from the top into a stainless steel nozzle trough. The curtain lace is fed through the nozzle from the bottom up into and through the slot in the top of the nozzle and looped over to one side, then the lock ring is slipped over the lace and top of the nozzle, locking the lace.**

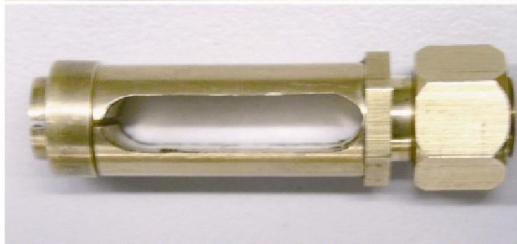

**The slot in the top of the nozzle to align with the row of nozzles. The bottom of the nozzle must protrude beneath the pan by a minimum of 3mm\0.125" to prevent the water from spreading out horizontally causing overspray and splash.**

**Normal spacing between nozzles is appr. 38mm\1.5" between centers.**

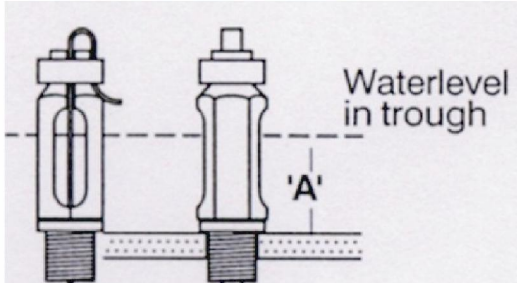

**Nozzle Flows: HT-CF40  
'A': 13mm/0.5" = 0.25L/min (4GPH)**





# Electric Heater for Spa

**Heaters contain all of the sophisticated features and capabilities of heaters twice their size. The electric heaters fit into compact spaces- even under spa skirts or steps. They are easy to install and service.**

## Applications

**Spas/ hot tubs/ pools**

## Features

- **Standardization 304 stainless steel tank**
- **304 stainless steel threaded head, safety sensor electric heating element**
- **Electric overload protection**
- **Indicator light**
- **Alternative direction connections**
- **Operation (on/ off) by pressure function**
- **Easy for transportation**



Code Model	KW	Voltage	Connect Size
HTH-5	5.5	220/380v	1.5"
HTH-7	7.5	220/380v	1.5"
HTH-10	10	220/380v	1.5"
HTL-18	18	380v	2"
HTL-24	24	380v	2"
HTL-30	30	380v	2"
HTL-36	36	380v	2"/3"
HTL-54	54	380v	2"/3"
HTL-60	60	380v	2"/3"

## overall size

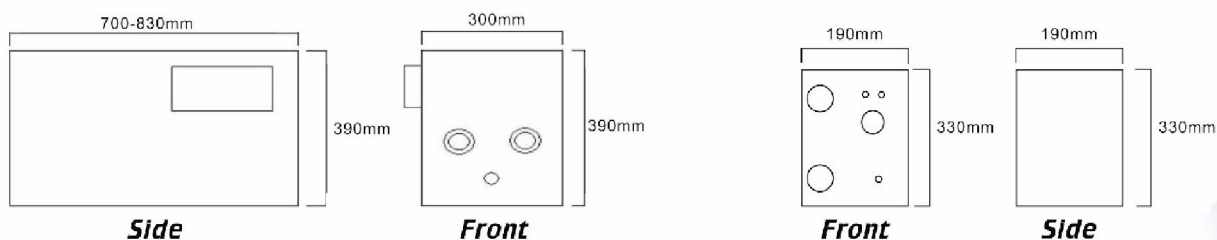



# Steam Generator

**A steambath can moisturize and deeply clean the skin. It relax overworked, tight muscles and reduces aches and pains in joints. A personal steambath will improve the quality of your life.**

**Features:**

**Quiet operation**

**Efficient installation**

**Stainless steel tank construction**

**Easily removable heating elements for easy and economical services**

**Control box with PCB and wireless (IFR ray) remote controller**

**Sensitive temperature sensor and polished chrome steam head**

**Standard manual drain or optional automatic drain**



Model	KW	Volt	Max m <sup>3</sup>
AH03	3.0	220/380v	1.5-2.5
AH04	4.5	220/380v	2.5-4
AH06	6.0	220/380v	4-6
AH07	7.5	220/380v	6-8
AH09	9.0	220/380v	8-10
AH10	10.5	220/380v	10-12
AH12	12.0	220/380v	12-14



**Steam Control Panel & Remote Control**



**Sauna Control Panel & Remote Control**



**Sensor**

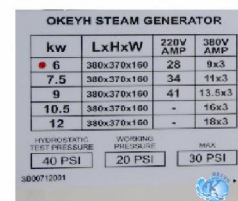

**Steam Generator Label**

# Sauna Accessories



**Sauna Wooden Pail and  
Wooden Ladle**



**Sauna Light**

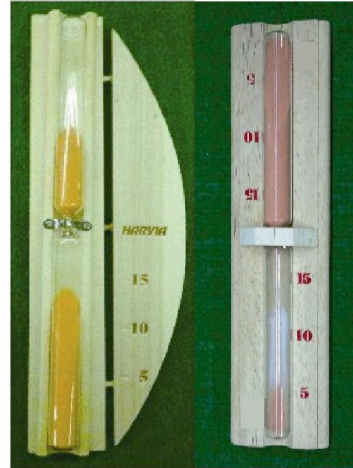

**Sauna Sandtimer**



**Sauna Thermometer**



**Sauna Thermometer**



**Sauna Stone**



**Heating Elements**



**Coates  
Heating Elements**

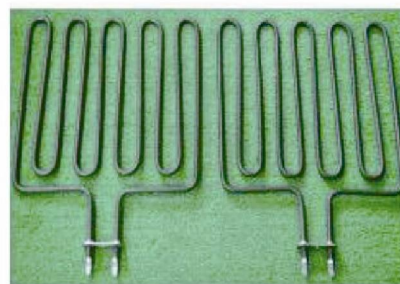

**Butterfly  
Heating Elements**

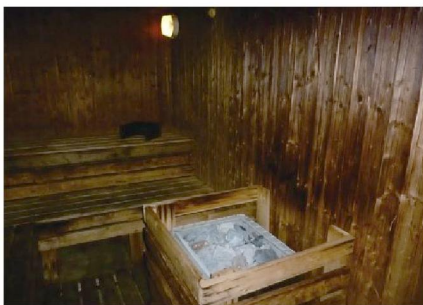



**OKEYH POOL**

**TATHING POOL LIMITED**

**Workshop F, G/F, Universal Ind. Centre, Nos 19-25 Shan Mei Street, Fotan N.T. Hong Kong  
Manufactory in Jiangmen, Guangdong**